



HEAD OFFICE:

2001 Albion Road, Units 17-20, Toronto, ON Canada M9W 6V6
Tel: 416-674-2552 Fax: 1-888-329-2910
www.gateway-graphics.com E-mail: sales@gateway-graphics.com

WESTERN OFFICE:

3721 Bonnington Road, Bonnington, BC Canada V0G 2G3
Tel: 250-359-5083 Fax: 250-359-5084
E-mail: peobrien@shaw.ca



**Serving North America's Lumber,
Panel & Wood Packaging Industries**

PRODUCT LIST

Grade Stamps, Strips and Bands	3
Lumber Marking Ink	4
Pre-Inked Rolls.....	5
Dry Ink Rolls.....	5
Wood and Metal Mounts.....	6
Wood Mounts.....	6
3-Way Mounts.....	6
Metal Rocker Mounts.....	6
End Stamping and Edge Marking.....	6
Gateway Stamping Hammers.....	7
Pressure-Fit, Plate-Backed, Plain or Velcro.....	7
Pre-Inked and Dry Stamp Pads.....	7
GHC Hand Printers.....	8
HP-100 and HP-200 Hand Printers.....	9
G-22 Printer For Plywood, OSB, E.W.P.....	9
G-Series Line Printers.....	10
G-9, G-14 and G-29.....	10
Gateway Stud Printer.....	11
Automated Panel & OSB Face Grade Printers.....	12
Automated Lumber Face Grade Printers.....	13
Stencil Systems.....	14
Aluminum, Mylar, Oilboard and Brass Interlocking.....	14
Stencil Roller Applicators, Ink Roller, Dry Pads and Ink.....	14
Lumber Crayons and Markers.....	15
Crayon Holders.....	15
Grain Scribes.....	15

GRADE STAMPS, STRIPS & BANDS

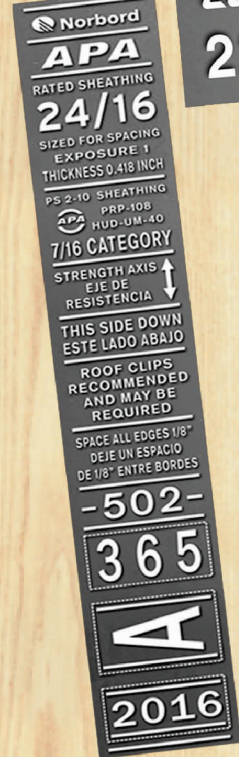
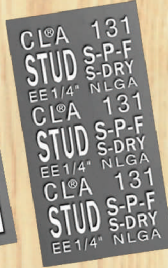

- High quality, deep molded rubber stamps
- Special rubber formulations for increased clarity and durability
- Lumber and panel grade stamps. HT, IPPC, date and shift codes, company logos etc.
- Custom single stamps, multiple impression belts and bands
- Available in plain, adhesive, Velcro, brass or plate backing
- Our Velcro backed stamps are both professionally sewn and glued with our special glue formulation which resists delaminating of the Velcro from the rubber
- We supply lumber mills and grading agencies throughout North America and around the world

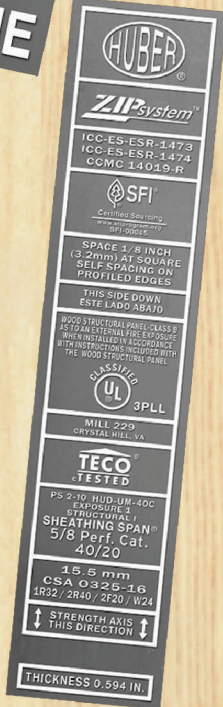

LUMBER MARKING INK



Gateway's Ink Is Specially Formulated By Our Chemist and Approved By The Engineered Wood Association (APA)

- No excessive wicking or running
- Practically odourless
- Crisp, sharp colours
- Permanent
- Weather & UV light resistant
- Shipped as non-dangerous goods
- Available in Black, Red, Green & Blue



Gallons
Quarts
Pints



Available in
1qt., 1 gal., 5 gal. pail,
55 gal. drum, 265 gal. tote

Ideal For Inking Stamp Pads

Perfect For Ink Rolls

Great For Stencilling

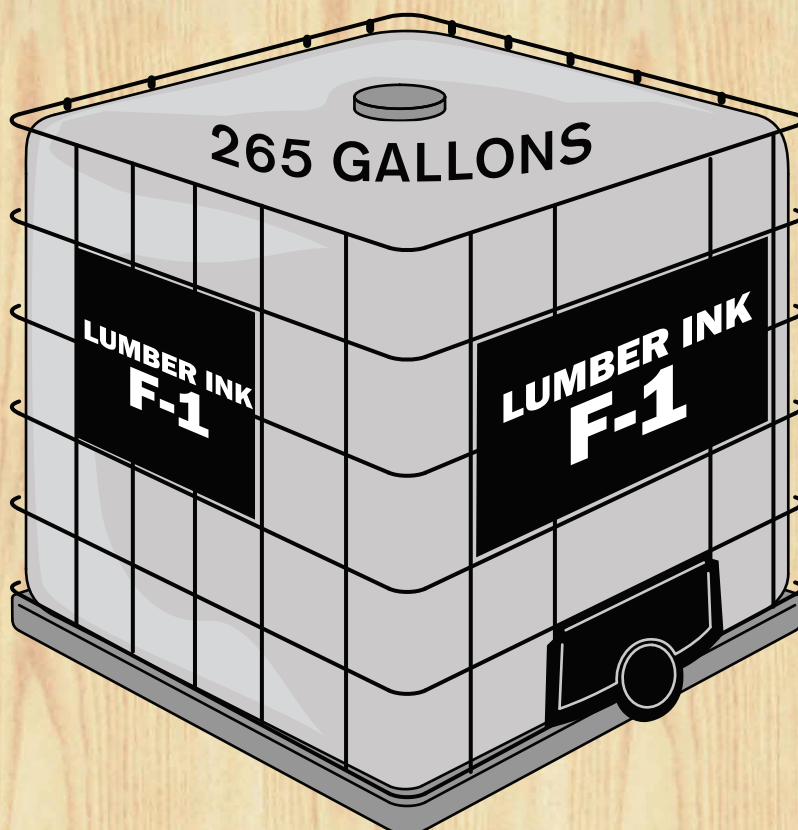
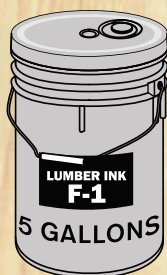

PRE-INKED ROLLS

Approved by the Engineered Wood Association (APA) for use in the wood products industry



- We carry a full range of sizes to fit any grade printing equipment
- Available in black, red, blue, green and more
- Very soft to extra firm in hardness
- Non-toxic with no harsh fumes or chemicals

DRY INK ROLLS

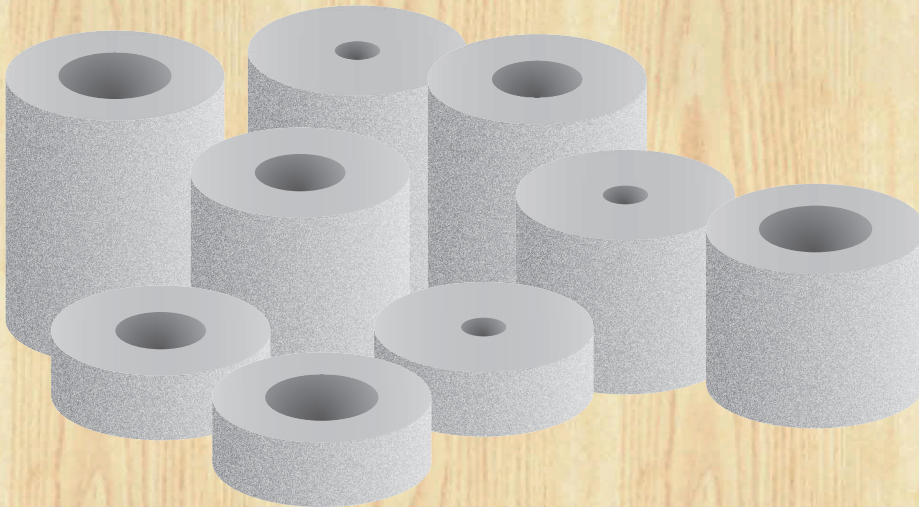

- For manual or ink-fed marking systems
- Use with Gateway F-1 black or coloured inks
- Soft, firm, or extra firm rolls for marking with rubber or steel die
- Available in a full range of sizes
- Free samples available upon request

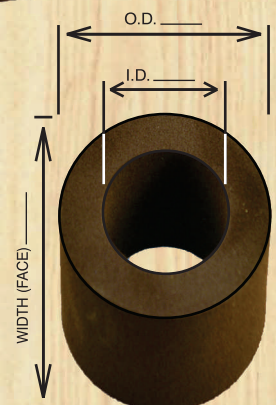

WOOD AND METAL MOUNTS

The 3-way wood mount allows the grader to easily switch between stamps. Available in 1-1/4" x 3" or 1-1/2" x 3".

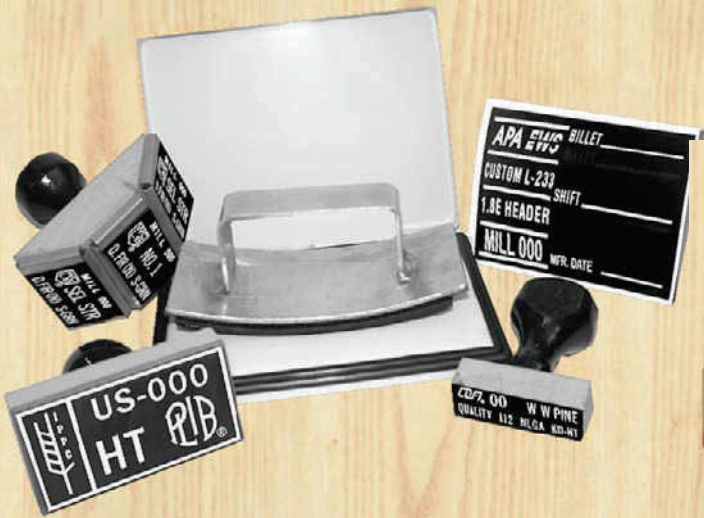

WOOD MOUNTS

- Custom cut wood mounts for all applications
- A variety of sizes and handles available to suit every need
- Rubber die custom made to your specifications
- Attached with either permanent glue or Velcro for easy replacement



METAL ROCKER MOUNTS

Rocker mounts are used with larger stamps for better transfer of impressions. Stamps can be attached with sticky back, permanent glue or Velcro for easy replacement.

FOR USE WITH GATEWAY STAMP PADS AND F-1 LUMBER INK

END STAMPING AND EDGE MARKING



- Narrow stamps and mounts for end stamping 1" and 2" boards
- End rollers for continuous printing on lumber, plywood, OSB and pallets



GATEWAY STAMPING HAMMERS

WELL BALANCED AND LIGHTWEIGHT
DURABLE, SOLID RUBBER HEADS WITH HARDWOOD HANDLES
INCLUDES CRAYON HOLDER WITH TIGHTENING RING

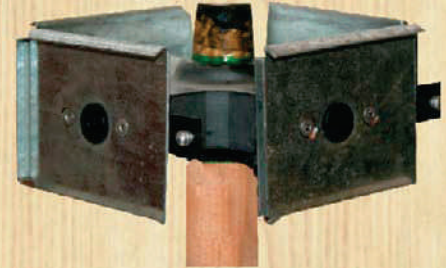
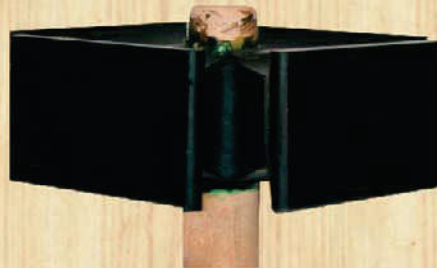
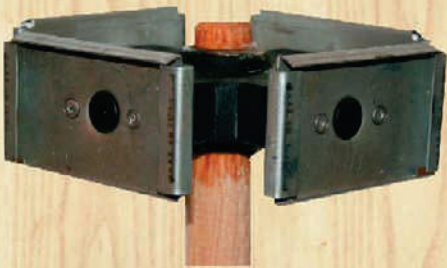

PRESSURE FIT

No glue, no screws, no Velcro. Stamps are just squeezed in behind metal tabs and will not come off.

PLAIN OR VELCRO

Stamps can be attached permanently on solid rubber heads or for easy replacement using Velcro.

PLATE BACKED

Plate backed stamps simply slide into place and back out for changes.

PRE-INKED & DRY PADS



PRE-INKED STAMP PADS

- Heavy duty steel casing for long lasting usage
- Pre-inked replacement inserts are available in Black, Red, Blue and Green
- Available in: 4" x 5-7/8"

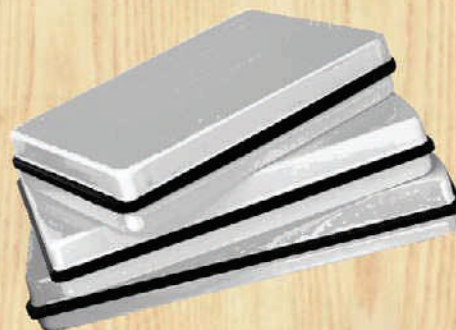

Cloth covered dry stamp pads with heavy duty steel casing available in the following sizes:

- 4" x 5-7/8"
- 4-3/4" x 6-3/4"
- 5-7/8" x 7-7/8"
- 7-7/8" x 11-3/4"

GHC SERIES HAND PRINTERS

FAST, RELIABLE, CONTINUOUS PRINTING

LIGHTWEIGHT AND COST EFFECTIVE

EASY ONE HAND APPLICATION

NO MESSY INKS AND STAMP PADS

DESIGNED FOR THE LUMBER AND PALLET INDUSTRY



FACE GRADE PRINTING

Gateway's **GHC Series Hand Printers** are the perfect solution for handheld lumber, panel and pallet marking. The self-inking feature allows for rapid, continuous printing without the need for messy inks and stamp pads. Pre-inked rolls provide up to 40,000 imprints per roll and are available in a variety of colours. The ink transfer rate is easily adjusted in seconds with a turn of the eccentric dial. Dry ink rolls are also available.

The print drums are available in continuous and indexing models and come pre-mounted with Velcro for quick and easy attachment and removal of stamps. The indexing models utilize a unique cam indexing mechanism to return the print drum to the same starting position when the printer is lifted away from the surface being marked. The index mechanism allows the print drum to rotate 360 degrees before reaching a positive stop. (This provides full use of the print area) A cushioned handle provides for a comfortable grip for extended use.

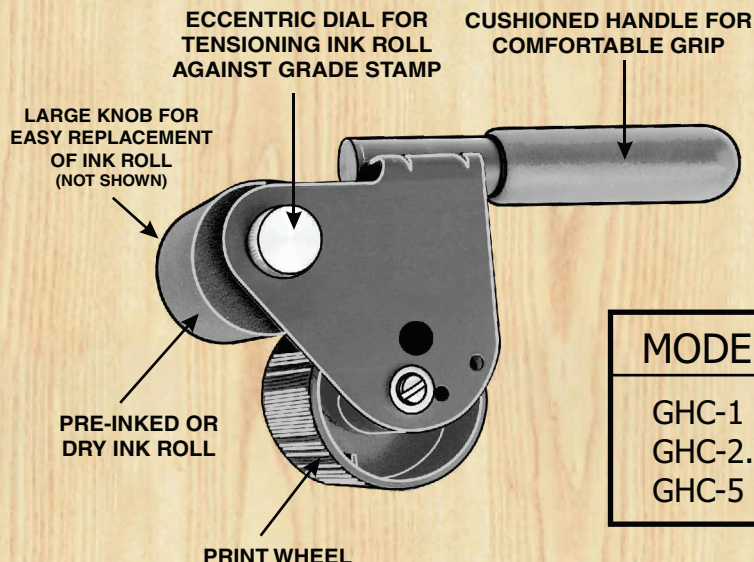

MODEL	PRINT AREA
GHC-1	1-3/4" x 10"
GHC-2.5	2-1/4" x 10"
GHC-5	4-3/4" x 10"

8 EDGE PRINTING

HP-100 & HP-200 HAND PRINTER

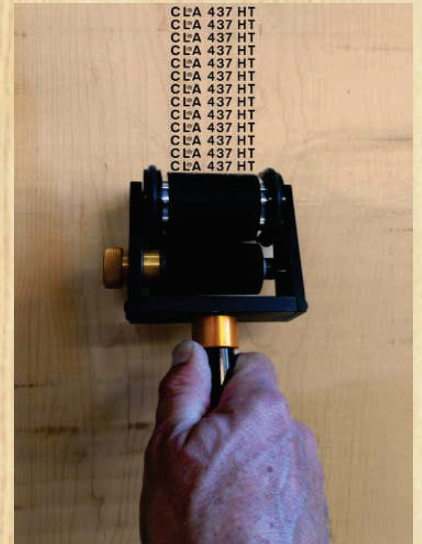
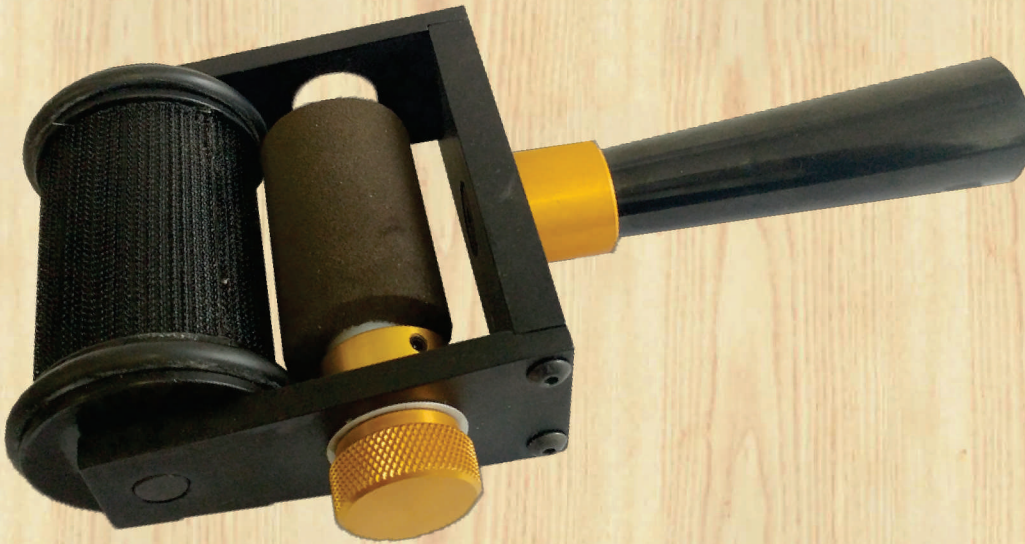

The **HP Hand Printers** are the perfect solution for applying date codes, lot numbers and other product information where automatic coding is not possible. These coders feature heavy duty precision machined components made from aircraft grade aluminum alloys, stainless steel mounting columns and shafts and sealed ball bearings for smooth print drum rotation. Available in both indexing and non-indexing, (continuous print) models.

The **HP-100NI** model features a 2" x 6.5" print area.

The **HP-200NI** model features a 2" x 9.1" print area.

Available with dry ink rolls only.

G-22 PRINTER FOR PLYWOOD, OSB, ENGINEERED WOOD PRODUCTS



The **G-22 Printer** is designed for off-line application of panel stamps and is made with a lightweight, aluminum alloy handle. Rolls easily across any panel surface leaving clear, crisp impressions. The print drum has a print area equal to most industrial line printers and Velcro mount for easy stamp changes. Comes with print wheels of various diameters and widths to fit any size stamp.

G-SERIES LINE PRINTERS (G-9, G-14, G-29)

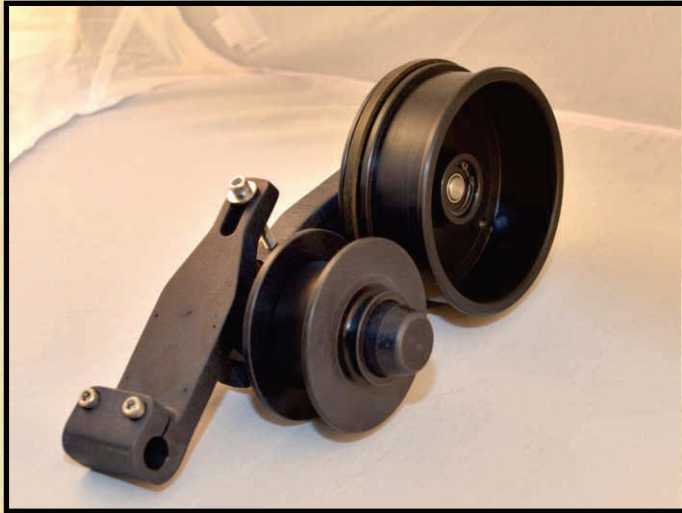

The **G-Series** are medium duty line printers designed to provide continuous impressions from a friction driven stamp wheel. The stamp hub has a rubber bumper on one side to absorb any shock and allow smooth application of stamp impression. These printers can be mounted directly above, beside, (left or right) or below the production line. The ink roll assembly snaps on and off with ease for quick, no mess changing of ink rolls.



- Durable. Built to last for years
- Pre-inked, disposable ink rolls give you sharp, clear impressions every time with no liquid mess
- Dry foam ink rolls also available
- Comes complete with mounting brackets
- Velcro backed stamps enable quick replacement; minimizing production downtime

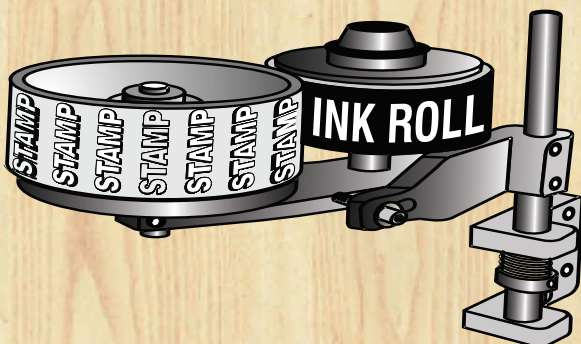

MODEL	PRINT AREA
G-9	7/8" X 16"
G-14	1-5/8" X 16"
G-29	3-3/4" X 16"
G-1.25	7/8" X 16"
G-2	1-5/8" X 16"
G-4	3-3/4" X 16"

GATEWAY STUD PRINTERS

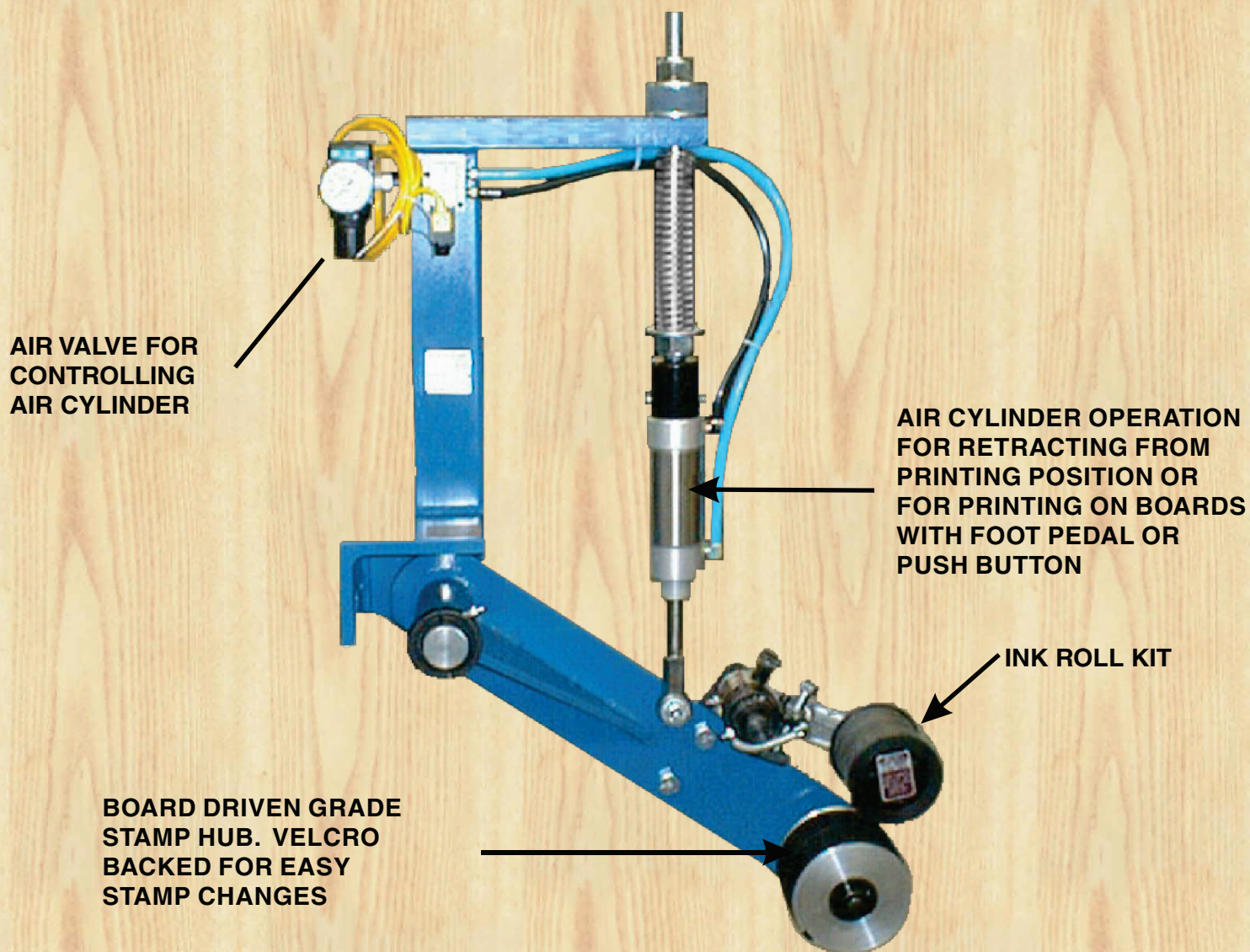

FEATURES

- All steel framework. Designed to handle most industrial lumber mill applications
- Can be mounted above, below or beside your production line
- Board driven for continuous printing, or air actuated and timed with most grade mark readers. In the air actuated models, a foot pedal, button or mill PLC is timed to the chain lugs to lift and drop the arm as the boards pass under
- Stamps attach easily with Velcro or snug fitting bands
- Standard size print wheels are 1-1/2", 3" or 6" wide
- Optional heated ink roll kits can be used to operate year round in cold conditions

AUTOMATED PANEL & OSB FACE GRADE PRINTERS

STATE OF THE ART - MILLWRIGHT DESIGNED

PRE-INKED ROLLS OR A FLO-THRU SYSTEM ARE AVAILABLE

2-1/2" OR 4" DIAMETER INK FLOW KITS

SINGLE OR DUAL CYLINDER

AIR DRIVEN FOR MAINTAINING CONSTANT DRUM SPEED TO LINE (OPTIONAL)

ALL PIVOT POINTS HAVE BRASS OILITE BUSHINGS

ALL STEEL FRAME

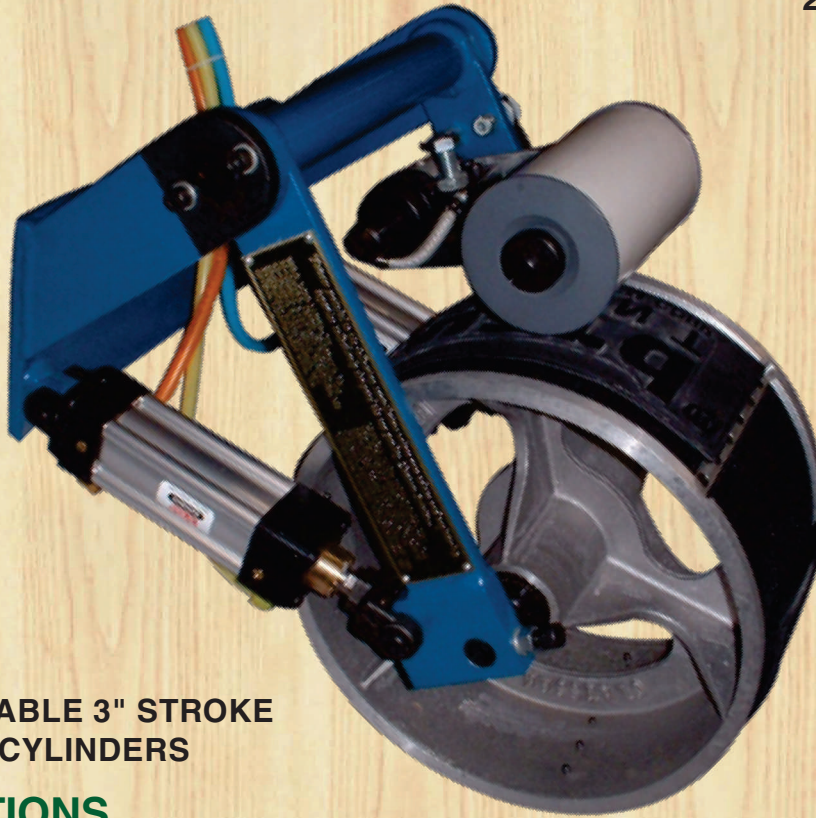

REBUILDABLE 3" STROKE AIR CYLINDERS

BENEFITS / OPTIONS

- All steel framework. Designed for industrial use
- Top or bottom mounting (optional)
- Dual air cylinders mean no down time as it will operate on only one cylinder
- Two large Oilite bushings support both ends of the air cylinders
- Board or air driven. Maintains the same speed as panels without skidding
- Grade stamps attach easily with Velcro
- Available in 12" or 15" diameter and 1-1/2" to 6" widths
- Stamps are inked by pre-inked rolls or by an ink flo-thru system
- Optional drum swivel for warped panels
- Optional internal ink roll heater
- Optional wet ink flo-thru system
- Model 1C Options: Single air cylinder
- Model 2C Options: Two cylinders and dual control panel
- Model 2CS Options: Two air cylinders, dual control panel and drum swivel



Weyerhaeuser
Made in Canada

APA

RATED SHEATHING

24/16

SIZED FOR SPACING

EXPOSURE 1

THICKNESS 0.418 IN

533

PS 2-10 SHEATHING



PRP-108

HUD-UM-40C

7/16 CATEGORY

CONSTRUCTION SHEATHING

1R24/2F16/W24

11.0 mm

CSA O325-16

EXTERIOR TYPE

ADHESIVE



SFI

Certified Sourcing

www.sfiprogram.org

SFI-00008



STRENGTH AXIS
THIS DIRECTION

woodbywy.com

THIS SIDE DOWN

AUTOMATED LUMBER FACE GRADE PRINTER

LOWEST MAINTENANCE AND OPERATING COSTS IN THE INDUSTRY!

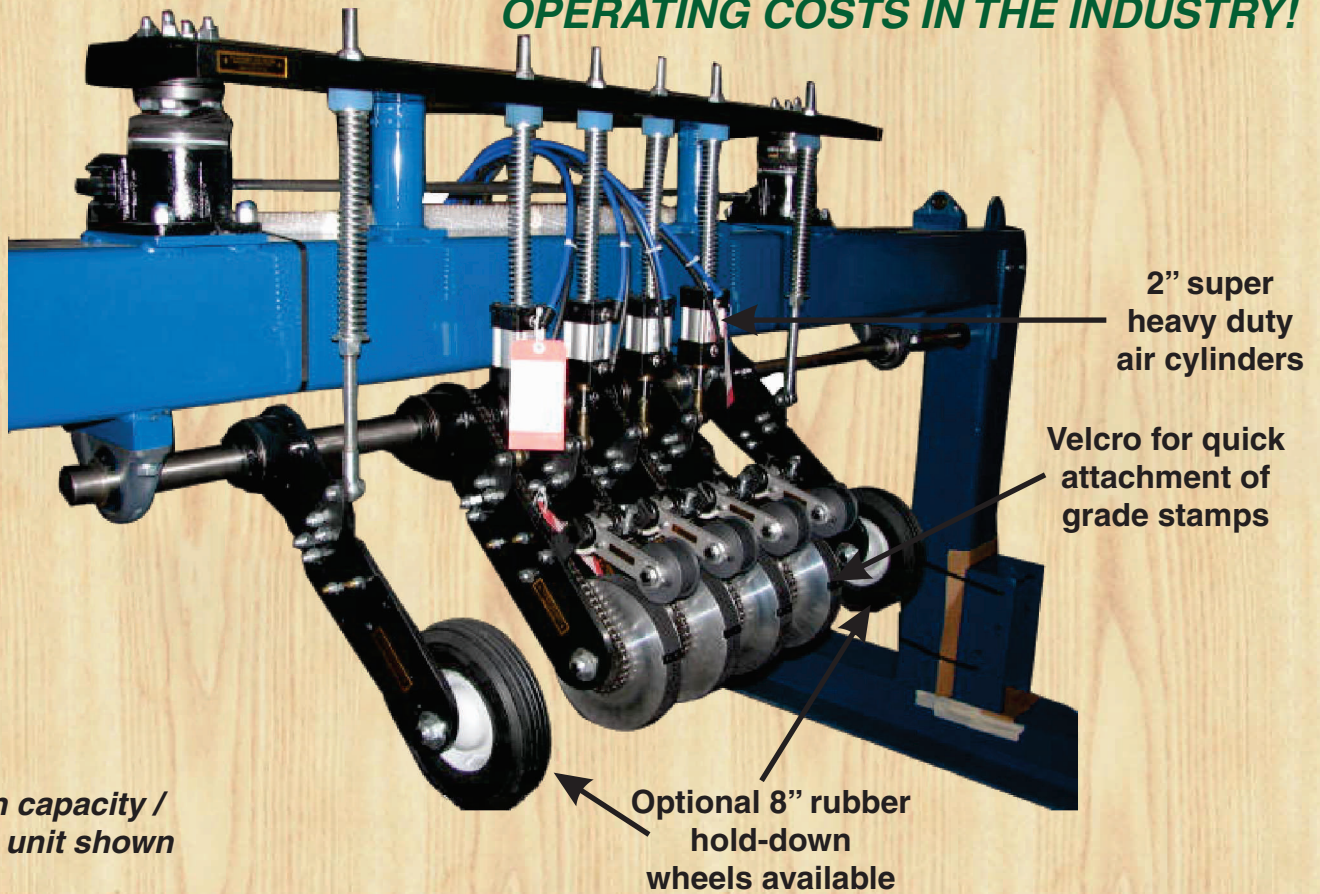

FEATURES

- PLC controlled, multiple grade system
- All steel framework, millwright designed for industrial use
- 5" clearance above boards for unobstructed clearance of warped or twisted boards. No double stamping
- Strain relief bending plates to protect against damage to drive shaft, arm and arm bearings
- All steel ball bearings
- Taper-Lock bushing system - No set screws
- Stamps are pre-inked by rolls or with an Ink-Flo system
- Burelbach, Hemco and Irvington Moore conversion arms available
- Grade stamps attach easily with Velcro, or as snug fitting bands
- Optional thickness adjuster; adjusts all arms simultaneously
- Optional patented internal ink roll heaters

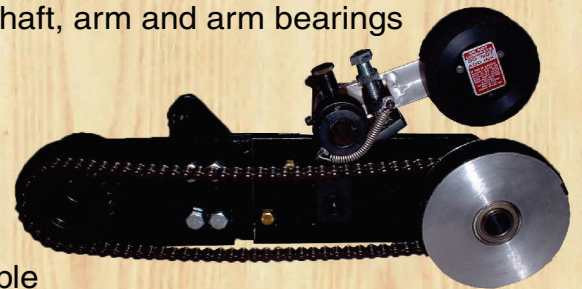

STENCIL SYSTEMS

ALUMINUM



Custom cut aluminum; all sizes and thicknesses.
Great for company logos, names and numbers.
Durable and long lasting.

MYLAR



Lightweight, durable and flexible; designed to your specifications. Can be easily cleaned with solvents. This reusable stencil is made from a .014 styrene and has a milky white appearance.

OILBOARD



Quick, inexpensive and disposable.
Available with a custom cut design to your specifications or blank. Made from 0.14 thick oil treated tag board.

BRASS INTERLOCKING



Letters slide together and come apart easily for quick, legible stencilling on all surfaces. Use with a brush, spray rollers or markers

APPLICATION SYSTEMS

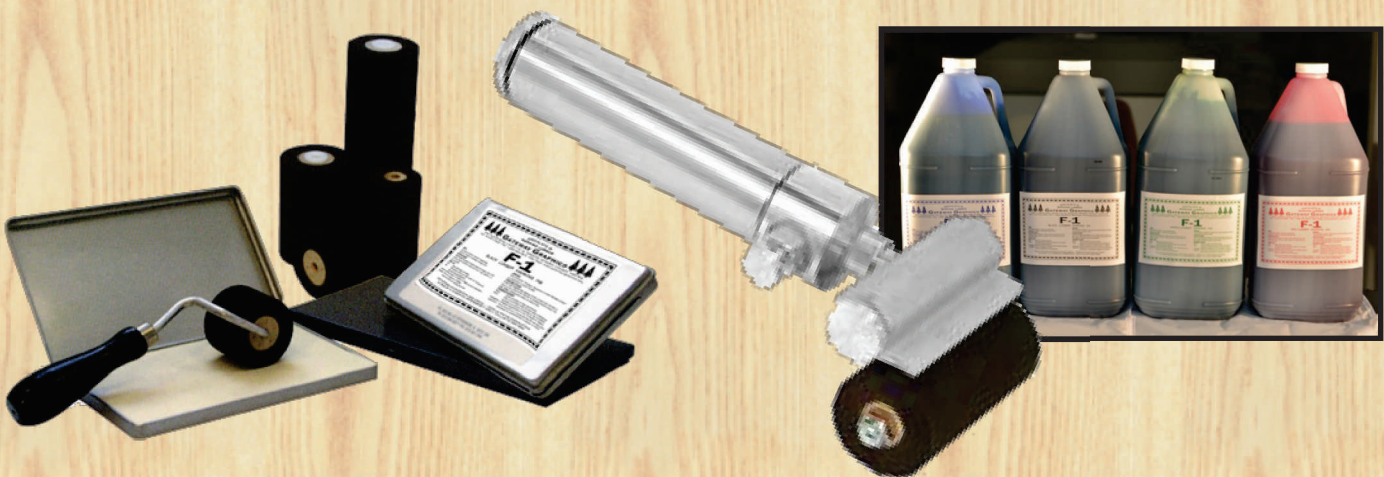

- Foam rollers: 1-1/2", 3" or 6"
- Dry stamp pads: 3" x 5" up to 8" x 12"
- F-1 lumber ink: Black, Blue, Red, Green
- Pint, quart, gallon and pails available

- Self-inking, push-button fountain roller
- Ink is contained in the roller handle and is pumped with a push-button motion.
- F-1 lumber ink in all colours and quantities

LUMBER CRAYONS AND MARKERS



LUMBER CRAYONS

- Available in 1/2" hex or 11/16" round sizes.
- Regular and fluorescent crayons for use with grade mark readers
- Brands include Dixon, Markal, Pro-Ex, Scan-It Plus and Ultrascan
- Railroad chalk, paint sticks, markers and other items available



CRAYON HOLDERS

Hardwood construction protects crayon from breakage. Comes with leather wrist thong.

- #112: 11/16" round
- #109: 1/2" hex



VALVE ACTION PAINT MARKER

- 14 standard and fluorescent colours for improved mark identification, quality control and parts inspection.
- Fast drying, permanent paint for immediate handling reduces downtime.
- Xylene-free paint reduces user health risks.

DURA-INK MARKER

Formulated to dry quickly and leave bold, highly visible marks. The industrial grade ink is safe for use on almost any surface and is smear and water resistant.



GRAIN SCRIBES

A must for determining slope of grain in lumber grading and log home building. Our grain scribes are made of precision cut brass with a hardened steel pin for dependable, long term use.



CONVENIENT STORAGE SLEEVE INCLUDED!

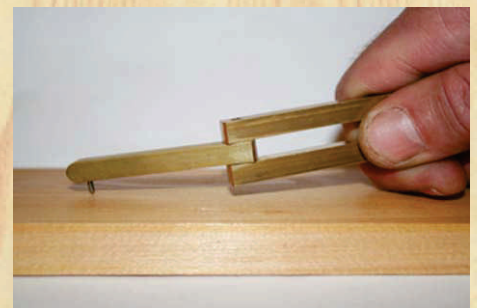



Serving the wood products industry for over 25 years!

**Please visit our website at www.gateway-graphics.com
for detailed descriptions of our products.**

HEAD OFFICE:

2001 Albion Road, Units 17-20, Toronto, ON Canada M9W 6V6
Tel: 416-674-2552 Fax: 1-888-329-2910
www.gateway-graphics.com E-mail: sales@gateway-graphics.com

WESTERN OFFICE:

3721 Bonnington Road, Bonnington, BC Canada V0G 2G3
Tel: 250-359-5083 Fax: 250-359-5084
E-mail: peobrien@shaw.ca